

CLARKE[®]

CONTRACTOR[®]



ANGLE GRINDER

MODEL NO: CON1150

PART NO: 6474015

OPERATING & MAINTENANCE INSTRUCTIONS



ORIGINAL INSTRUCTIONS

GC11/22-Rev1

INTRODUCTION

Thank you for purchasing this CLARKE Angle Grinder.

Your Angle Grinder has been designed to give long and trouble free service. If you encounter problems, return the unit to your local CLARKE dealer.

Before attempting to use this product, please read this manual thoroughly and follow the instructions carefully.



WARNING: THIS SYMBOL IS USED THROUGHOUT THE USER GUIDE WHEN THERE IS A RISK OF PERSONAL INJURY. MAKE SURE THAT THESE WARNINGS ARE READ AND UNDERSTOOD AT ALL TIMES.



CAUTION: THIS SYMBOL IS USED THROUGHOUT THE USER GUIDE WHEN THERE IS A RISK OF DAMAGE TO THE PRODUCT. MAKE SURE THAT THESE CAUTIONS ARE READ AND UNDERSTOOD AT ALL TIMES.

GUARANTEE

This product is guaranteed against faulty manufacture for a period of 12 months from the date of purchase. Please keep your receipt which will be required as proof of purchase.

This guarantee is invalid if the product is found to have been abused or tampered with in any way, or not used for the purpose for which it was intended.

Faulty goods should be returned to their place of purchase, no product can be returned to us without prior permission. This guarantee does not effect your statutory rights.

ENVIRONMENTAL RECYCLING POLICY



Through purchase of this product, the customer is taking on the obligation to deal with the WEEE in accordance with the WEEE regulations in relation to the treatment, recycling & recovery and environmentally sound disposal of the WEEE.

In effect, this means that this product must not be disposed of with general household waste. It must be disposed of according to the laws governing Waste Electrical and Electronic Equipment (WEEE) at a recognised disposal facility.

GENERAL SAFETY RULES



CAUTION: FAILURE TO FOLLOW THESE PRECAUTIONS COULD RESULT IN PERSONAL INJURY, AND/OR DAMAGE TO PROPERTY.

WORK ENVIRONMENT

1. **Keep the work area clean and well lit.** Cluttered and dark areas invite accidents.
2. **Do not operate power tools in explosive atmospheres, such as in the presence of flammable liquids, gases or dust.** Power tools create sparks which may ignite the dust or fumes.
3. **Keep children and bystanders away while operating a power tool. Anyone entering the work area must wear personal protective equipment.** Distractions can cause you to lose control and fragments of work or a broken disc may fly away and cause injury.
4. **Store power tools properly when not in use.** Abrasive products should be stored in a dry, secure place out of the reach of children.

ELECTRICAL SAFETY

1. **Power tool plugs must match the outlet. Never modify the plug in any way. Do not use adapter plugs with earthed (grounded) power tools.** Unmodified plugs and matching outlets will reduce the risk of electric shock.
2. **Do not expose power tools to rain or wet conditions.** Water entering a power tool will increase the risk of electric shock.
3. **Do not abuse the cable. Never use the cable for carrying, pulling or unplugging the power tool. Keep the cable away from heat, oil, sharp edges or moving parts.** Damaged or entangled cables increase the risk of electric shock.
4. **When operating a power tool outdoors, use an extension cable suitable for outdoor use.** Use of a cable suitable for outdoor use reduces the risk of electric shock.

PERSONAL SAFETY

1. **Stay alert, watch what you are doing and use common sense when operating a power tool.** Do not use a power tool while you are tired or under the influence of drugs, alcohol or medication. A moment of inattention while operating power tools may result in personal injury.

2. **Use personal protective equipment.** Always wear eye protection. Safety equipment such as dust mask, non-skid safety shoes, hand protection and a workshop apron capable of stopping small abrasive or workpiece fragments.
3. **Avoid accidental starting.** Ensure the switch is in the off position before plugging in. Carrying power tools with your finger on the switch or plugging in power tools that have the switch on invites accidents.
4. **Remove any adjusting key or wrench before turning the power tool on.** A wrench or a key left attached to a rotating part of the power tool may result in personal injury.
5. **Do not overreach.** Keep proper footing and balance at all times. This enables better control of the power tool in unexpected situations.
6. **Dress properly.** Do not wear loose clothing or jewellery.
7. **Keep your hair, clothing and gloves away from moving parts.** Loose clothes, jewellery or long hair can be caught in moving parts. Keep the work area clean and tidy.
8. **This tool vibrates with use.** Vibration may be harmful to your hands or arms. Stop using the tool if discomfort, a tingling feeling or pain occurs. Seek medical advice before resuming use.
9. **Hold the power tool by insulated gripping surfaces only, when performing an operation where the cutting tool could contact hidden wiring or its own cable.** Contacting a live wire may make exposed parts of the power tool live and give the operator an electric shock.
10. **Never lay a power tool down until it has come to a complete standstill.** The rotating accessory may grab the surface and pull the tool out of your control.
11. **Do not run the power tool while carrying it at your side.** Accidental contact with a spinning accessory could snag on clothing and pull the tool to your body.
12. **Regularly clean the power tool's air vents.** The motor fan will draw dust inside the housing and accumulation of material could cause electrical hazards.
13. **Avoid operator fatigue.** Stop the power tool at regular intervals for a short break to rest hands and arms.
14. **Maintain your tools.** Keep all handles and grips dry and clean.

ANGLE GRINDER SAFETY INSTRUCTIONS

1. **Before starting work, always consider the following:** The use of hand held angle grinders for grinding and cutting operations can present risks to the user. Full observation of the safety instructions in this user guide is essential.
2. **Before undertaking grinding or cutting operations, always consider the following:** Is the grinding/cutting work necessary? Could a different tool be used with less risk? (e.g. a fixed controlled cutting/grinding machine). Can the work be sensibly positioned, secured and accessed so the operator can maintain adequate control of the tool, taking into account, for example the possible hazards associated with potential snatch/jamming of a cutting disc. Is the cutting task too large for a hand held tool? If in doubt, use an alternative lower risk solution or refer to qualified trade personnel.
3. **Always use the correct tool for the job.** Always assess the job. You should never force a small angle grinder to do the job of a duty heavy tool. Do not use tools for purposes not intended.
4. **Always position the power cable clear of the spinning disc.** If you lose control, the cable may be cut or snagged and your hand drawn onto the spinning disc.
5. **Start up speed.** Always allow the angle grinder to run up to full operating speed before applying it to the job.
6. **Applying the disc to the workpiece.** Never bump the angle grinder disc on the workpiece, or let the disc hit any other objects while grinding.
7. **Do not abuse the mains lead.** Never carry the tool by the mains lead or pull it to disconnect it from the mains socket. Keep the mains lead away from heat, oil and sharp edges.
8. **Secure the work.** Use clamps or vices to hold the workpiece. Failure to secure the workpiece could result in serious injury.
9. **Remove adjusting keys and wrenches.** Form the habit of checking to see that keys and adjusting wrenches are removed from the tool before turning it on.
10. **Use outdoor extension leads.** When the tool is used outdoors, only use extension leads intended for outdoor use. Always make sure that the extension lead is correctly rated.
11. **Check damaged parts.** A guard or other parts that are damaged should be properly repaired or replaced by an authorised service centre, unless otherwise indicated in this user guide. Have defective switches replaced by an authorised service centre.

12. **Accessories. Only use the recommended accessories.** Ensure that the discs are fitted in accordance with the manufacturer's instructions.
13. **Only use discs that comply with EN12413 or EN13236.** Make sure that the disc used is suitable for the no load speed of the angle grinder. See Specifications on page 16. Check that the speed marked on the disc is compatible with the grinder. Check that discs are specifically for hand held angle grinder use.
14. **Sparks and particles.** Ensure that sparks and particles resulting from use do not create a hazard, use screens where appropriate.
15. **Personal protective equipment.** Always use protective safety glasses and dust mask. Use other protective equipment such as gloves, apron and helmet where necessary. If working at floor level, always wear knee pads.
16. **Switching off.** The disc will continue to rotate for a few seconds after the angle grinder is switched off. Always wait until the disc has completely stopped before putting the angle grinder down.
17. **Use the disc guard.** Do not use the angle grinder without the disc guard. Make sure that the guard is securely fitted and positioned for maximum safety before operating the angle grinder. Always use the correct guard for cutting or grinding work as described in this manual.
18. **The grinding surface of depressed centre discs must be mounted below the plane of the guard lip.** An improperly mounted disc that projects above the plane of the guard lip cannot be adequately protected.
19. **Holding the angle grinder.** Always hold the angle grinder with both hands. Ensure that the workpiece is kept at waist height where possible. Never use the angle grinder between the legs whilst sitting on the floor.
20. **Feed direction.** For cutting, always feed the disc into the work so that an upcutting action is achieved.
21. **Spindle lock.** Do not operate the spindle lock while the spindle is still spinning.
22. **Beware of kickback.** Always take care to avoid kickback by maintaining a firm grip of the tool and positioning your body and arm to resist kickback forces. Always use the auxiliary handle for maximum control.
23. **Avoid moving parts.** Never position your hand close to the rotating parts and take special care when working in corners or with sharp edges, or any situation where the disc could snag.

DISC SAFETY INSTRUCTIONS

1. **Disc speed.** Check the speed of the disc before fitting to your angle grinder. Never use a disc with a guaranteed rpm speed less than the rpm speed of your angle grinder. See specification on page 16.
2. The outside diameter and thickness of your accessories must be within the capacity rating of the power tool. The correct size accessories can be correctly guarded and controlled.
3. **Inspect the disc before fitting.** Never use a disc that is chipped, cracked or damaged. Fragments from a broken or damaged disc can cause serious injury. Make sure that defective discs are destroyed and not used.
4. **Handling and mounting discs.** Bonded abrasive products are breakable and shall therefore be handled with utmost care. The use of damaged or improperly mounted or used abrasive products is dangerous and can cause serious injuries.
5. **Disc usage.** Always refer to the label for specified usage and observe the safety information. Do not use for purposes other than specified. Discs for wet cutting applications must not be used with this angle grinder.
6. **Use the correct disc.** Always use the correct disc for it's intended task. Using the wrong disc can cause serious injury.
7. **Using the disc.** Allow the disc and tool to do the work. Never force the disc onto the workpiece as this could cause kickback and/or shatter the disc causing serious injury. Kickback can occur in the event of a disc jam.
8. **Cutting discs.** Do not use cutting discs for side grinding. Do not put sideways pressure on cutting discs.
9. **Do not use reducing bushes.** Do not use separate reducing bushes or adapters to adapt large hole abrasive discs. Do not force a disc onto a grinding machine or alter the size of the arbor hole.
10. **Never use a damaged disc.** Inspect each disc before each use for chips, cracks, excess wear. If the tool or accessory is dropped, inspect for damage or install a new accessory. After fitting the accessory, position yourself away from the plane of the rotating accessory and run the tool at full speed. damaged discs are likely to break apart during this test.
11. **Handling and storing discs.** Abrasive products shall be handled and transported with care. Abrasive products shall be stored in such a manner that they are not subjected to mechanical damage and harmful environmental influences.
12. **Always use suitable mounting discs.** Ensure they are of the correct size and shape for your cutting or grinding disc to support the disc and reduce the possibility of breakage.

SAFETY SYMBOLS

The following safety symbols may be found on the machine.



Wear dust mask



Wear eye protection

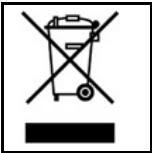

Falls within WEEE Directive (see page 2)



Read instruction manual before use



Wear hand protection

ELECTRICAL CONNECTIONS



WARNING: READ THESE ELECTRICAL SAFETY INSTRUCTIONS FULLY BEFORE CONNECTING THE MACHINE TO THE MAINS SUPPLY.

This product is provided with a standard 13 amp, 230 volt (50Hz), BS 1363 plug, for connection to a standard, domestic electrical supply. Should the plug need changing, make sure that a plug of identical specification is used.



**WARNING: THE WIRES IN THE CABLE ARE COLOURED AS FOLLOWS:
BLUE = NEUTRAL BROWN = LIVE**

If the colours of the wires in the power cable do not correspond with the markings on the terminals of your plug, proceed as follows.

- Connect the **blue** wire to the terminal which is marked **N**.
- Connect the **brown** wire to the terminal which is marked **L**.

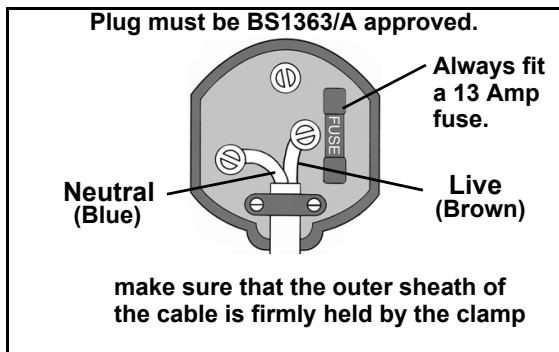

AN APPROVED RESIDUAL CURRENT DEVICE (RCD) WHICH HAS A TRIPPING CURRENT OF LESS THAN 30mA MUST BE USED.

If you are not sure, consult a qualified electrician. **DO NOT** try to do any repairs.



This symbol indicates that this is a Class II product, and does not require an earth connection.

OVERVIEW



NO	DESCRIPTION	NO	DESCRIPTION
1	Spindle Lock Button	5	Trigger
2	Grinding/Cutting Disc	6	Trigger Safety Lock Button
3	Disc Guard	7	Speed Controller
4	Auxiliary Handle		

When unpacking, check for damage or shortages etc. Any found should be reported to your CLARKE dealer where the product was originally purchased. The CON150 is supplied with the following loose components:

- 2 x Disc Guards
- 1 x Grinding Disc
- 1 x Pin Spanner
- 1 x Handle
- 2 x Securing Discs
- Pair Carbon Brushes

BEFORE USE

SELECTING THE CORRECT GUARD

Both open and a closed guard are supplied with the CON1150.

The "open" guard is for grinding and the "closed" one is for cutting.

The open guard should be used with type 27, 28 and 29 discs as follows;

- Type 27 - Depressed centre grinding discs
- Type 28 - Depressed centre grinding discs cone shaped
- Type 29 - Depressed centre semi-flexible discs

The closed guard should be used with type 1, 41 & 42 discs as follows;

- Type 1 - Straight grinding discs
- Type 41 - Flat cutting off discs
- Type 42 - Depressed centre cutting off discs.

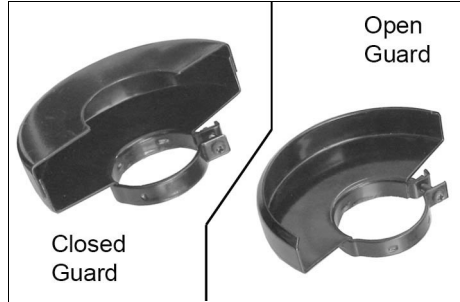

SELECTING SUITABLE ABRASIVE AND CUTTING DISCS

The following Clarke discs are suitable for use with the CON1150. Always use the correct disc and guard type for its intended task.

Use	Model No	Diameter	Bore	Part No
Cutting & Grinding	PD1 (plasma)	115 mm	22 mm	3052050
Metal Cutting	-----	115 mm	22 mm	6470775
Metal Grinding	-----	115 mm	22 mm	6470705
Masonry Cutting	-----	115 mm	22 mm	6470735

FITTING/ADJUSTING THE DISC GUARD



WARNING: MAKE SURE THAT THE ANGLE GRINDER IS SWITCHED OFF AND UNPLUGGED FROM THE MAINS SUPPLY BEFORE FITTING OR REMOVING ANY ACCESSORIES. ENSURE THE CORRECT GUARD IS FITTED FOR THE DISC BEING USED.

WARNING: THE DISC GUARD SHOULD BE FITTED SO THAT IT PROVIDES MAXIMUM PROTECTION TO THE USER WHEN IN THE WORKING POSITION.

1. Slide the disc guard into place as shown.
2. Rotate the disc guard to the required position and secure by tightening the screw.
3. Ensure the disc guard is securely fitted before using the grinder.



FITTING/REMOVING A DISC



WARNING: MAKE SURE THAT THE ANGLE GRINDER IS SWITCHED OFF AND UNPLUGGED FROM THE MAINS SUPPLY BEFORE FITTING OR REMOVING ANY ACCESSORIES.

Make sure the correct disc guard is fitted before you fit any cutting or grinding disc.

1. Press and hold the spindle lock button.
 - You will need to turn the spindle by hand to fully engage the spindle lock.
2. Use the pin spanner supplied to remove the outer retaining disc.
3. Ensure the inner retaining disc is fitted correctly, with the raised "flats" on the inner side engaging with the corresponding flat section on the spindle.
4. Place the grinding disc over the spindle and on top of the inner retaining disc.
 - If the grinding discs supplied is a depressed centre type, mount it as shown, i.e. with the depressed centre (printed side) towards the machine.

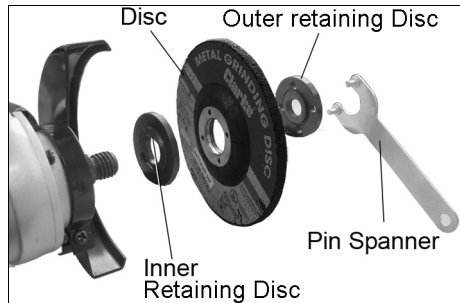

- For standard discs make sure that the raised centre section of the outer retaining disc is pointing towards the grinding disc
5. Screw on the outer retaining disc with the raised section facing inwards so as to sit inside the aperture of the disc. Tighten securely with the pin spanner.
 - When using thin discs, the outer retaining disc can be reversed so that the raised section is pointing away from the grinding disc.
 6. With the spindle lock engaged, use the pin spanner to tighten the outer retaining disc. Care should be taken also NOT to overtighten.

FITTING THE AUXILIARY HANDLE

1. Fit the auxiliary handle by screwing it into the threaded hole on either the top, left or right hand side of the angle grinder.



OPERATION



WARNING: FRAGMENTS FROM A BROKEN/DETACHED DISC CAN CAUSE SERIOUS INJURY.

WARNING: WHEN USING CUTTING DISCS, DO NOT STAND DIRECTLY IN LINE WITH THE ROTATING DISC.

WARNING: DO NOT PUT LATERAL PRESSURE ON CUTTING DISCS.

WARNING: ENSURE THAT THE WORKING POSITION ADOPTED DOES NOT CAUSE OPERATOR FATIGUE WHICH MAY LEAD TO LOSS OF CONTROL OF THE CUTTING DISC AND IMPACT/SNATCH WITH SURROUNDING OBJECTS.

WARNING: ENSURE THE INTENDED CUTTING PATH IS CLEAR AND WITH SUFFICIENT CLEARANCE BETWEEN SURROUNDING OBJECTS.

WARNING: WHEN CUTTING, KEEP THE ANGLE GRINDER STRAIGHT TO PREVENT SNATCHING OR JAMMING OBJECTS.

WARNING: ALWAYS FIT THE CORRECT GUARD ACCORDING TO WHETHER A CUTTING OR GRINDING DISC IS BEING USED. REFER TO PAGE 11.

SWITCHING ON/OFF

1. To start the angle grinder, press and hold the safety button (1) and squeeze the trigger (2).
 - The disc will start instantly. Always maintain a firm grip with both hands.
2. To stop the angle grinder, release the trigger.
3. Set your chosen speed by rotating the speed control wheel (3).



WARNING: THE DISC WILL CONTINUE TO ROTATE FOR A FEW SECONDS AFTER THE TRIGGER HAS BEEN RELEASED.

CUTTING TIPS

- Do not force the disc through the material. Work with a feed rate that is suited to the material being cut.
- Do not subject the cutting disc to sideways pressure.

- The direction of the cutting motion is important. Always feed the cutting disc into the work so that it cuts in an upward direction. If you do not do this it can result in the disc climbing out of the cut in an uncontrolled manner and may lead to loss of control or serious injury.
- Whenever a new disc has been fitted, always run the grinder at no load speed to check for irregularities before starting work.

GRINDING TIPS



WARNING: WHEN GRINDING, ONLY USE DISCS SPECIFICALLY DESIGNED FOR GRINDING. YOU MUST NEVER USE CUTTING DISCS TO GRIND ANY MATERIAL.

- The key to efficient grinding is to control the pressure and surface contact between the grinding disc and the workpiece.
 - Flat surfaces are ground at an acute angle, usually 15 to 30 degrees to the workpiece. Too great an angle causes concentration of pressure on a small area which may gouge, or burn the workpiece.
 - Allow the disc to reach full speed before grinding.
 - Avoid overloading the angle grinder. If it becomes hot when being used, allow it to run for a few minutes under no-load conditions.
-

MAINTENANCE

GENERAL MAINTENANCE

1. Always have your angle grinder inspected and maintained by qualified service personnel. Do not attempt to repair the angle grinder unless you are qualified to do so.
2. Make sure that all nuts, bolts and screws are tight and secure.
3. Check the side handle and the guard for damage.
4. Always have any damaged, or worn parts repaired or replaced.
5. Ensure the grinding or cutting disc is perfectly sound, free from cracks or damage.
6. Inspect the power cable to ensure it is sound and free from cracks or bare wires etc.

CLEANING



To maintain the best possible performance from your angle grinder, it must be kept clean.



1. Ensure all air ventilation slots are clear, (use compressed air to clean the machine if possible. Always wear protective goggles when cleaning with compressed air).
2. Clean the product with a soft cleaning cloth. Never use any chemicals or harsh abrasives. Avoid using solvents when cleaning plastic parts, which may be susceptible to damage from various types of commercial solvents.
3. After extensive use the carbon brushes in the drive motor may require replacement and a spare pair are provided for fitting by your dealer.

SPECIFICATIONS

Model Number	CON1150
Dimensions (L x W x H)	400 x 130 x 104 mm
Weight	2.35 kg with open guard fitted 2.48 kg with closed guard fitted
Power Supply	230V - 50Hz
Input Power	1150 W
Abrasive Disc Diameter (max)	115 mm
Abrasive Disc thickness	6 mm
Abrasive Disc Bore	22 mm
Spindle Thread Size	M14
Speed Range (step-less/10% tolerance)	3000 to 11,000 rpm
Duty Cycle	S1 (continuous)
Sound Pressure Level (LpA dB)	89.7 dB(A)
Sound Power Measured (LwA dB)	100.97 dB(A)
Uncertainty	3 dB
Vibration Emissions	8.685 m/s ² (Main Handle) 7.890 m/s ² (Aux Handle)
Uncertainty value	1.5 m/s ²

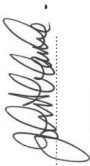
DECLARATIONS OF CONFORMITY

	 <p>Hemmill Street, Epping, Essex CM16 4LG</p>	<p>DECLARATION OF CONFORMITY</p>	<p>This is an important document and should be retained.</p>	<p>We hereby declare that this product(s) complies with the following statutory requirement(s):</p>	<p><i>Electromagnetic Compatibility Regulations 2016</i> <i>Supply of Machinery (Safety) Regulations 2008</i> <i>The Restriction of the Use of Certain Hazardous Substances in Electrical and Electronic Equipment Regulations 2012</i></p>	<p>The following standards have been applied to the product(s):</p>	<p>EN 55014-1:2017, EN 55014-2:2015, EN IEC 61000-3-2:2019, EN 61000-3-3:2013 + A1, EN 60745-1:2009 + A11, EN 60745-2-3:2011, IEC 62321-1:2013, IEC 62321-2:2013, IEC 62321-3-1:2013, IEC 62321-4:2013 + AMD1:2017 CSV, IEC 62321-5:2013, IEC 62321-6:2015, IEC 62321-7-1:2015, IEC 62321-7-2:2017, IEC 62321-8:2017, ISO 17075:2017.</p>	<p>The technical documentation required to demonstrate that the product(s) meet(s) the requirement(s) of the aforementioned legislation has been compiled and is available for inspection by the relevant enforcement authorities.</p>	<p>The UKCA mark was first applied in: 2022</p>	<p>Product Description: 115mm Angle Grinder (230V) Model number(s): CON1150 Serial / batch Number: N/A Date of Issue: 20/10/2022</p>	<p>Signed: </p>	<p>J.A. Clarke Director</p>	<p>CON1150 UKCA Clarke DOC 10022</p>	<p>Page 1 of 1</p>
---	---	---	--	---	---	---	---	--	---	---	---	---------------------------------	--------------------------------------	--------------------

	 <p>Fitzwilliam Hall, Fitzwilliam Place, Dublin 2</p>	<p>DECLARATION OF CONFORMITY</p>	<p>This is an important document and should be retained.</p>	<p>We hereby declare that this product(s) complies with the following directive(s):</p>	<p><i>2014/30/EU Electromagnetic Compatibility Directive</i> <i>2006/42/EC Machinery Directive</i> <i>2011/65/EU Restriction of the Use of Certain Hazardous Substances in Electrical & Electronic Equipment (RoHS) Directive</i></p>	<p>The following standards have been applied to the product(s):</p>	<p>EN 55014-1:2017, EN 55014-2:2015, EN IEC 61000-3-2:2019, EN 61000-3-3:2013 + A1, EN 60745-1:2009 + A11, EN 60745-2-3:2011, IEC 62321-1:2013, IEC 62321-2:2013, IEC 62321-3-1:2013, IEC 62321-4:2013 + AMD1:2017 CSV, IEC 62321-5:2013, IEC 62321-6:2015, IEC 62321-7-1:2015, IEC 62321-7-2:2017, IEC 62321-8:2017, ISO 17075:2017.</p>	<p>The technical documentation required to demonstrate that the product(s) meet(s) the requirement(s) of the aforementioned directive(s) has been compiled and is available for inspection by the relevant enforcement authorities.</p>	<p>The CE mark was first applied in: 2018</p>	<p>Product Description: 115mm Angle Grinder (230V) Model number(s): CON1150 Serial / batch Number: N/A Date of Issue: 20/10/2022</p>	<p>Signed: </p>	<p>J.A. Clarke Director</p>	<p>CON1150 CE Clarke DOC 10022</p>	<p>Page 1 of 1</p>
---	--	---	--	---	---	---	---	---	---	---	---	---------------------------------	------------------------------------	--------------------

PARTS LIST & DIAGRAM

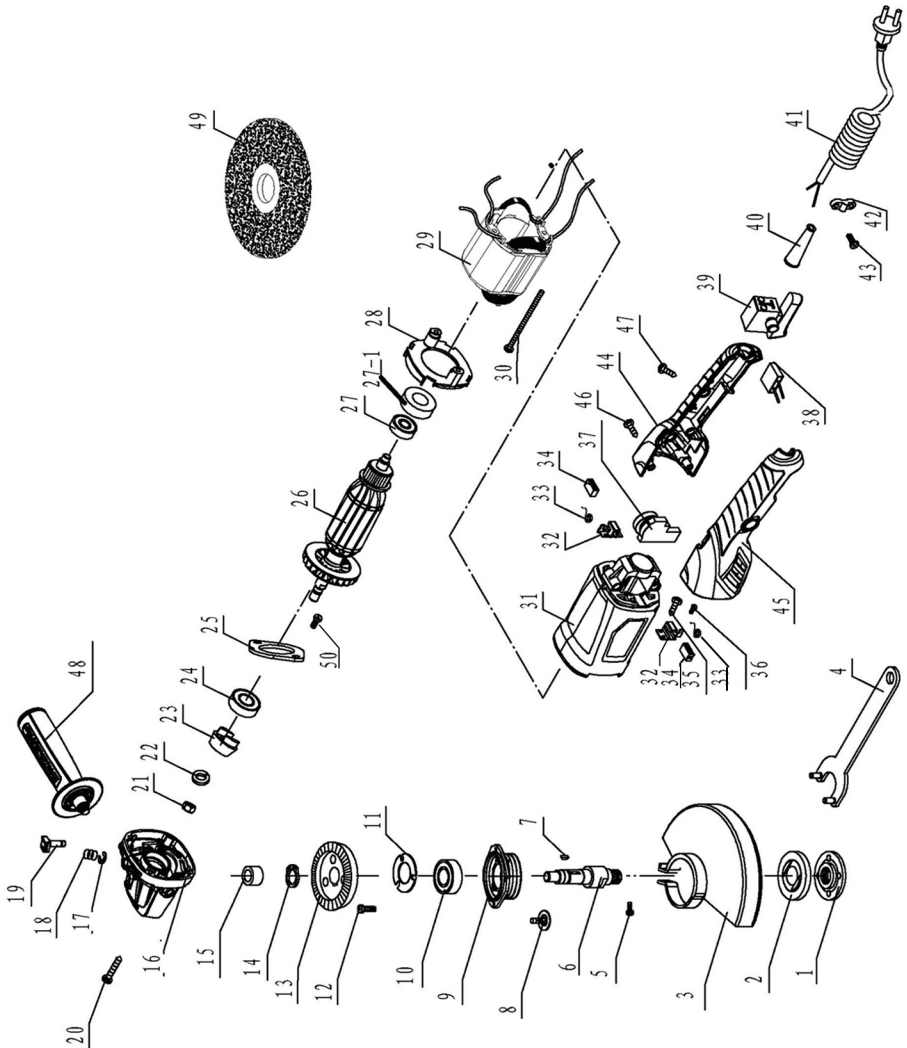

PARTS LIST

No	Description
1	Outer Retaining Disc
2	Inner Retaining Disc
3	Safety Guard
4	Pin Spanner
5	Screw M5 x 16
6	Spindle
7	Woodruffe Key
8	Cross head Screw M4x14
9	Front Cover
10	Bearing 6201
11	Bearing retainer
12	Cross head Screw M4x10
13	Primary Gear
14	Circlip 10mm
15	Copper Bush
16	Gearbox
17	Split Washer 5mm
18	Spindle Lock Spring
19	Spindle Lock
20	Cross head ST Screw M4x25
21	Nut M8
22	Spring Washer 8mm
23	Secondary Gear
24	Bearing 629
25	Bearing retainer
26	Rotor

No	Description
27	Bearing 607
27-1	Leather Collar 607
28	Baffle
29	Stator
30	Cross head ST Screw M4x70
31	Housing
32	Carbon Brush Holder
33	Spring
34	Carbon Brush
35	Cross head ST Screw M3x10
36	Cross head ST Screw/gasket
37	Speed Controller
38	Capacitor
39	Switch
40	Cable Sleeve
41	Power Cable
42	Cable Clamp
43	Cross head ST Screw M4x12
44	Right Handle
45	Left Handle
46	Cross head ST Screw M4x30
47	Cross head ST Screw M4x16
48	Side Handle
49	Disc
50	Machine Screw

A SELECTION FROM THE VAST RANGE OF

Clarke®

QUALITY PRODUCTS



AIR COMPRESSORS

From DIY to industrial, Plus air tools, spray guns and accessories.

GENERATORS

Prime duty or emergency standby for business, home and leisure.

POWER WASHERS

Hot and cold, electric and engine driven - we have what you need

WELDERS

Mig, Arc, Tig and Spot. From DIY to auto/industrial.

METALWORKING

Drills, grinders and saws for DIY and professional use.

WOODWORKING

Saws, sanders, lathes, mortisers and dust extraction.

HYDRAULICS

Cranes, body repair kits, transmission jacks for all types of workshop use.

WATER PUMPS

Submersible, electric and engine driven for DIY, agriculture and industry.

POWER TOOLS

Angle grinders, cordless drill sets, saws and sanders.

STARTERS/CHARGERS

All sizes for car and commercial use.

PARTS & SERVICE:

0208 988 7400

Parts Enquiries

Parts@clarkeinternational.com

Servicing & Technical Enquiries

Service@clarkeinternational.com

SALES: UK 01992 565333 or Export 00 44 (0)1992 565335

Clarke INTERNATIONAL Hemnall Street, Epping, Essex CM16 4LG
www.clarkeinternational.com